

Sustainability Report

2021



WE.MOVE.FUTURE



Content

01	Foreword				
02	Who We Are				
03	About the Report				
04	General Information	21	Ethical Business	33	Social Sustainability
05	Worldwide	22	Anti-corruption and Conflicts of Interest	34	Occupational Health and Safety Protection
06	Our Mission	23	Whistleblowing	36	Education and Training
07	Our Products and Customers	24	Compliance	37	Freedom of Association and Collective Bargaining
08	Our Supply Chain	25	Confidentiality, Data Protection & Cybersecurity	38	Local Communities
09	Our Employees	26	Procurement Practices	41	KIRCHHOFF Culture Life
10	Governance			42	GRI Content Index
12	Risk Management			45	Imprint
13	Vision and Values	27	Environmental Sustainability		
14	Code of Conduct				
15	Memberships	28	Materials and Waste		
16	Sustainability Initiatives	29	Energy and Water Consumption		
17	Stakeholder Communication	31	Greenhouse Gas Emissions		
18	Economic Performance	32	Biodiversity		
19	Innovations				

Foreword

Dear Ladies and Gentlemen,

the economic activity in 2021 was dominated by the effects of the coronavirus pandemic and problems in global supply chains. Thanks to strong crisis management supported by all employees, we can be quite satisfied with the results, even if they could not reach the pre-crisis level. Due to our far-reaching coronavirus protection measures, 95% of the workforce was back at work in the office or in a regulated home office by the end of 2021. Consistent implementation of mandatory mask-wearing, home office where possible, daily testing, and large vaccination campaigns in the factories have saved us from major sick leave in the workforce throughout the year.

Thanks to prudent supply chain management, we were always able to supply our customers. Unfortunately due to the continued shortage of semiconductors, our customers produced fewer cars, which resulted in less orders being placed for parts. The Russian army's invasion of Ukraine has now made it clear to us that one of the great challenges of the coming years will be to make our supply chains even more robust without completely questioning globalization.

Despite these crises, we do not lose sight of the biggest challenge of slowing down and ultimately stopping climate change; we see promising developments in the automotive industry. Our safety-relevant lightweight body parts will be predominantly installed in zero-emission electric vehicles in the coming years. This trend is not only in Europe and China, but also emerging in North America too. Even though our company only has a small impact on the overall CO₂ balance of our products, more than 90% of the CO₂ is generated during the production of steel and aluminum before we process it further. However, we still want to further improve.

In May 2022, we held a four-day workshop for this purpose, at which the top management confirmed our ambitious sustainability roadmap and defined additional measures to reduce CO₂ during production. Our goals include the further development of our consistent resource-saving lightweight design, with a simultaneous increase in recycled secondary material. In order to establish a high level of sustainability in supply chains in the automotive industry, we founded the association "Responsible Supply Chain Initiative (RSCI) e.V." at the end of 2021 together with ten major German automobile manufacturers and suppliers.

We also want to raise awareness of sustainable management and living in our workforces with numerous initiatives. The most visible campaign is certainly the tree planting initiative in the KIRCHHOFF Group; with the help of our employees and their families, we have planted around 25,000 trees in many countries. As a shareholder of a company with a history of almost 240 years, sustainable management is without doubt our commitment for future generations. It is also an opportunity to make our company even stronger and more economically successful in the coming years. I am convinced that we will succeed in both.

Best regards and good luck,



J. Wolfgang Kirchoff,
CEO KIRCHHOFF Automotive

Who We Are

KIRCHHOFF Automotive is the largest division of the KIRCHHOFF Group. The group of companies includes three other business units:

- WITTE Tools: manufactures premium screwdrivers and other tools in the sector
- KIRCHHOFF Ecotec: the leading supplier of waste disposal solutions and street cleaning technologies with its five brands FAUN, ZOELLER, HIDRO-MAK, Superior Pak, and FARID
- KIRCHHOFF Mobility: one of the leading providers of customized vehicle conversions that give people options for more mobility

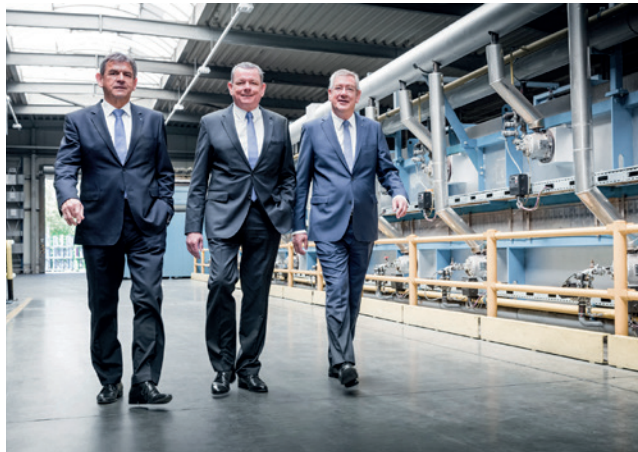

Johannes F., J. Wolfgang and Arndt G. Kirchhoff (from left to right)

The KIRCHHOFF Group traces its roots back to the sewing needle factory opened by Stephan Witte in Iserlohn, Germany in 1785. 100 years later in 1894, Friedrich Kirchhoff opened the first pressing plant at the site and began manufacturing for the mobility sector. Initially producing for the railroad industry, they later segued into the emerging automotive industry. During the 1980s, KIRCHHOFF Automotive expanded its business in the area of parts production for passenger vehicles, and in 1994 entered the field of waste disposal and cleaning technology with the acquisition of FAUN. Since 2006, the mobility business unit has been part of the KIRCHHOFF Group. The former focus of Witte switched to the production of hand tools as early as 1950.

Family Business

Knowledge. Values. Change – This was the motto under which the KIRCHHOFF Group celebrated its 235th anniversary in 2020. From the beginning and into the future, we are committed to this motto.

For four generations, the KIRCHHOFF Group has been entirely owned by the Kirchhoff family. Today, it is under the management of the three brothers Arndt G. Kirchhoff, Johannes F. Kirchhoff, and J. Wolfgang Kirchhoff. Sustainable development in the interest of future generations is at the heart of the Kirchhoff family's actions. This applies to the economic stability and innovative capacity of the companies, including the environmental and social commitment of all business units.



About the Report

The KIRCHHOFF Automotive 2021 Sustainability Report provides a comprehensive overview of KIRCHHOFF Automotive's strategy, goals, and performance with regard to sustainability.

Some of the data in this report is also included in the KIRCHHOFF Automotive Annual Report and as such is subject to external audit. Our sustainability reporting is with reference to the guidelines of the Global Reporting Initiative (GRI).

Our operating sites as of 31.12.2021:

In Europe:

KIRCHHOFF Automotive Germany, Attendorn (2)
 KIRCHHOFF Automotive Germany, Iserlohn
 KIRCHHOFF Automotive Germany, Saarwellingen
 KIRCHHOFF Automotive Poland, Mielec (2)
 KIRCHHOFF Automotive Poland, Gliwice
 KIRCHHOFF Automotive Poland, Gniezno
 KIRCHHOFF Automotive Portugal, Ovar
 KIRCHHOFF Automotive Portugal, Cucujães
 KIRCHHOFF Automotive Spain, Figueruelas
 KIRCHHOFF Automotive Ireland, Letterkenny
 KIRCHHOFF Automotive Hungary, Esztergom
 KIRCHHOFF Automotive Romania, Craiova
 KIRCHHOFF Automotive Romania, Pitesti

The report analyzes the company's commitment to a range of sustainability matters, from economic and governance to environmental and social sustainability. In doing so, it takes into account our most important markets, the requirements of our stakeholders, the current legal situation, and the structural needs of our company. It identifies our products and services, as well as the important ethical, social, environmental, and corporate policy aspects that influence our actions and environment.

In North America:

KIRCHHOFF Automotive Canada, Aurora
 KIRCHHOFF Automotive Canada, North York
 KIRCHHOFF Automotive USA, Atlanta
 KIRCHHOFF Automotive USA, Dallas
 KIRCHHOFF Automotive USA, Manchester
 KIRCHHOFF Automotive USA, Lansing
 KIRCHHOFF Automotive USA, Tecumseh
 KIRCHHOFF Automotive USA, Waverly
 KIRCHHOFF Automotive Mexico, Puebla
 KIRCHHOFF Automotive Mexico, Querétaro

In Asia:

KIRCHHOFF Automotive China, Suzhou
 KIRCHHOFF Automotive China, Shenyang

Reporting period and scope

This report covers the period between January 1, 2021 and December 31, 2021. It relates to the business activities of all KIRCHHOFF Automotive GmbH companies, which is a company of the KIRCHHOFF Group with its registered office at Stefanstraße 2, D-58638 Iserlohn, Germany.

Distinctions from companies mentioned in the annual report

In contrast to the annual report, we do not use the legal names of the KIRCHHOFF Automotive national companies in the Sustainability Report, but instead name the individual locations (see table; (2) stands for parallel parts production and tool-shops).

Operating as an independent business unit, KIRCHHOFF Mobility GmbH & Co. KG mentioned in the annual report, is not included in this report.

Significant changes in the organization

In 2021, we closed our sales offices in Saint Petersburg and São Paulo.

Alongside parts production, there are tool production facilities in Attendorn and in Mielec. They are identified by the index (2).



WE.MOVE.FUTURE



General Information

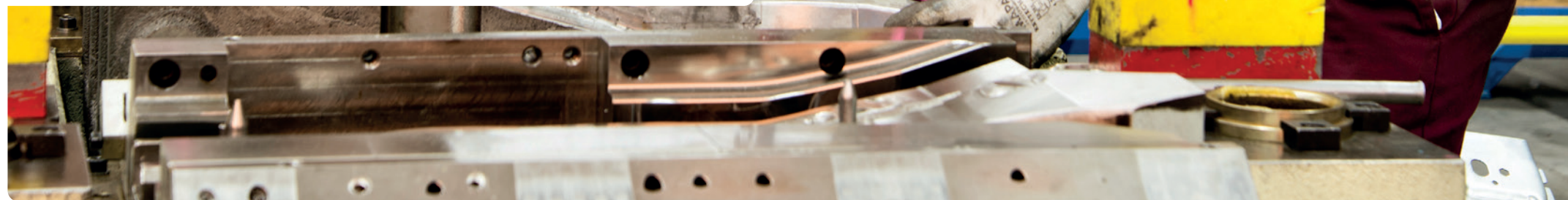

Worldwide



📍 27 Plants

- | | |
|-----------------------------|---------------|
| 01 Letterkenny | 14 Craiova |
| 02 Cucujães | 15 Pitesti |
| 03 Ovar | 16 Shenyang |
| 04 Figueruelas | 17 Suzhou |
| 05 Saarwellingen | 18 Puebla |
| 06 Attendorn | 19 Querétaro |
| 07 Attendorn
(Tool-shop) | 20 Dallas |
| 08 Iserlohn | 21 Atlanta |
| 09 Gniezno | 22 Manchester |
| 10 Gliwice | 23 Waverly |
| 11 Mielec | 24 Tecumseh |
| 12 Mielec
(Tool-shop) | 25 Lansing |
| 13 Esztergom | 26 Aurora |
| | 27 North York |

📍 8 Sales Offices

- | | |
|-------------|-------------------|
| 01 Chartres | 05 Troy |
| 02 Seoul | 06 Wolfsburg |
| 03 Kobe | 07 München |
| 04 Dongguan | 08 Mladá Boleslav |

👥 7.400 Employees

Our Mission

KIRCHHOFF Automotive is a global leader in the development and supply of best-in-class structures for vehicle bodies and chassis. We offer body solutions that make tomorrow's mobility safe. Our innovative and economical lightweight products ensure that people are optimally protected in the event of an accident.

As a development partner to the automotive industry, we develop and produce complex metal and hybrid structures for body-in-white and chassis that are lightweight, economical, and crash proof. KIRCHHOFF Automotive components also contribute to climate responsibility and environmental protection because they reduce the weight – and thus the fuel consumption - of vehicles.

Core Competencies

As a global player, we offer our customers in Europe, Asia, and North America comprehensive expertise in the areas of economical lightweight construction and crash performance. With the advanced technology of partial press hardening, KIRCHHOFF Automotive is able to produce steel products with different strength ranges, offering innovative weight- and crash-optimized body components.

Our core competencies are:

- Research and Development
- Forming
- Joining
- Lightweight Construction
- Surface Treatment

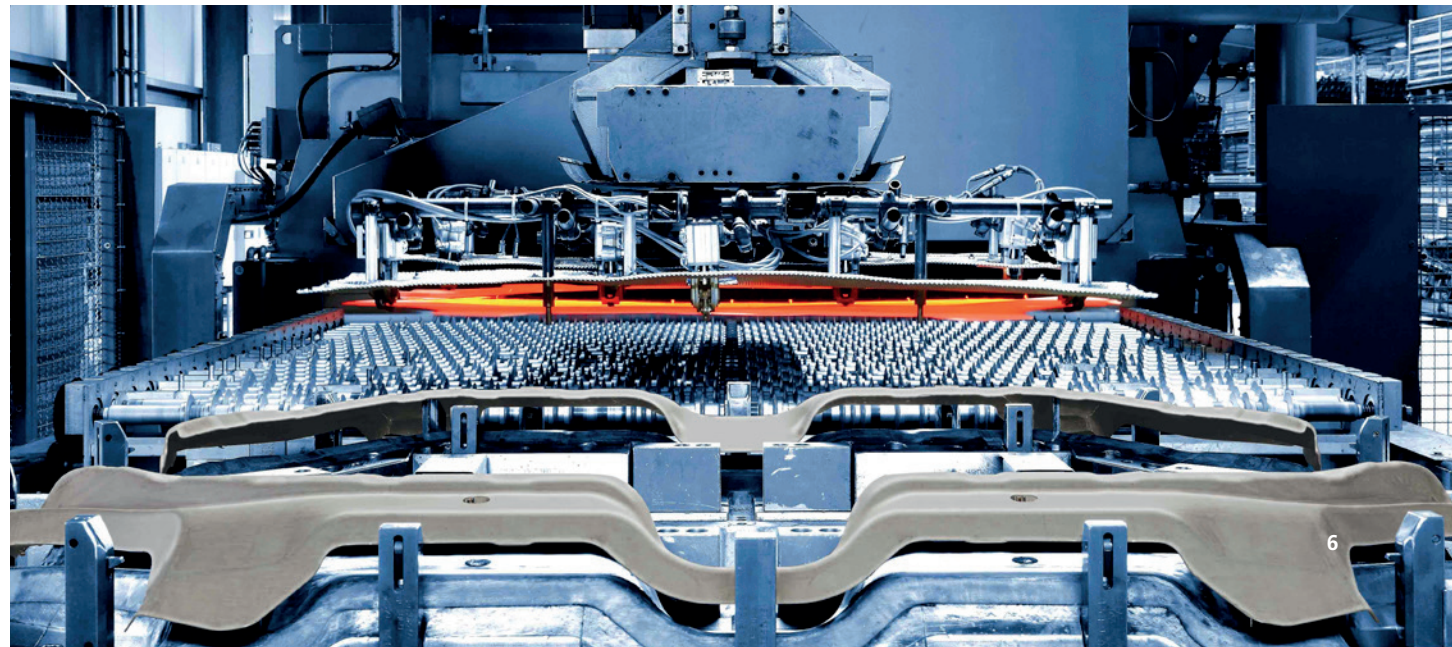

Our Products and Customers

With almost 7,400 employees and 27 plants in eleven countries, KIRCHHOFF Automotive ensures optimum customer proximity. We assemble most of our products into a wide variety of components in just-in-time plants near our customers' locations.

Our products in the passenger car sector include bumpers, cross members and engine bearers, battery housings for e-mobility, and other structural parts. For commercial vehicles, we develop and manufacture, among other things, cross members, axle housings, and underride protection. Our main materials are steels with thicknesses between 0.6 and 12 millimeters and tensile strength of up to 2,000 megapascals, as well as aluminum.

Our Customers

KIRCHHOFF Automotive's customer base is diversified so that we can compensate for fluctuations in the automotive markets. Our partners include all major automotive manufacturers worldwide. Among them are the Volkswagen Group, BMW, Daimler, General Motors, Ford, Honda, Suzuki, Hyundai-Kia, Geely/Volvo, and various electric vehicle manufacturers worldwide.

With our experience, wide product portfolio, and large network of locations, we meet the requirements of our global customers. We support them at all stages of the product lifecycle: from research and development to materials procurement and production, quality assurance, and delivery.

31 %

of passenger cars and light commercial vehicles produced worldwide in 2021 contained at least one component from KIRCHHOFF Automotive

In North America it was

62 %

In Europe

62 %

And in Germany

90 %



Our Supply Chain

KIRCHHOFF Automotive buyers in Europe, North America, and Asia are always on the lookout for the most efficient suppliers, service providers, and development partners who can best meet customers' requirements. Crucial to joint success are reliable, available, high-quality goods and services at competitive prices.

To make optimum use of synergies and economies of scale, we have divided our supply chain into four material areas:

- Raw materials: steel and aluminum producers, service centers
- Purchased parts: tubes, screws, nuts, bolts, plastic parts
- Capital goods: presses, welding and assembly equipment, tools and tooling components
- Indirect goods: electricity, gas, auxiliary and operating materials, services

Requirements for Suppliers

KIRCHHOFF Automotive suppliers must comply with various international and company standards and guidelines.

These include:

- Quality management according to ISO 9001 and respectively IATF 16949
- Environmental management according to ISO 14001:2015
- Innovative technologies and processes
- Consistent implementation of the zero-defect principle
- Competitive benefit-cost ratio
- Supply security and adherence to delivery dates
- Disposition for product and process optimization
- High standard of service
- Acceptance of our purchasing and basic conditions
- Acceptance of the KIRCHHOFF Automotive Code of Conduct's "Supplier Supplement"

This approach ensures responsible business practices for the company and that we do not work with organizations or partners that disregard these standards.



Our Employees

Committed and well-trained employees are the most important success factor of KIRCHHOFF Automotive. We offer employees internal career and development opportunities so that every employee can make the most of their potential. Together, our employees on three continents bring the company's vision to life: WE.MOVE.FUTURE.

As of the end of 2021, KIRCHHOFF Automotive employed around 7,400 people. The vast majority had a permanent, full-time employment contract. The available data was collected individually at the locations for the 2021 financial year and then amalgamated together.

Our Approach to Gender Equality

Workforce diversity and equal opportunities regardless of gender, origin, age, religion, and lifestyle, are central components of sustainable development here at KIRCHHOFF Automotive. This especially includes equal opportunities and advancement for women.

As part of our global talent management strategy, we promote women and men equally. As a company that is primarily characterized by technical job profiles, we take into account both industry-specific factors and the current proportion of women in the workforce when setting our targets for the advancement of women.



Employees

by gender and employment relationship (2021)

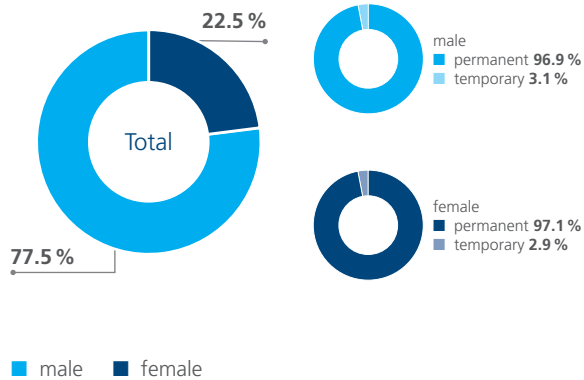

Employees

by region and employment relationship (2021)

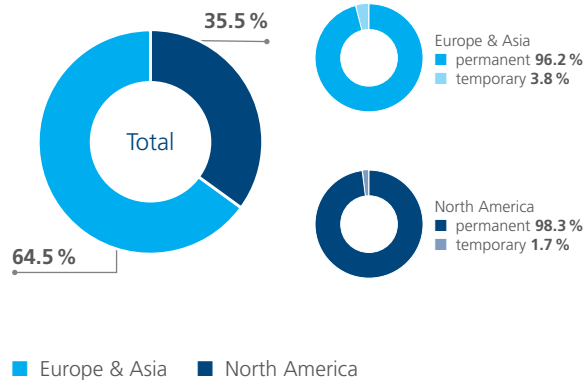

Employees

by working hours, gender, and region (2021)

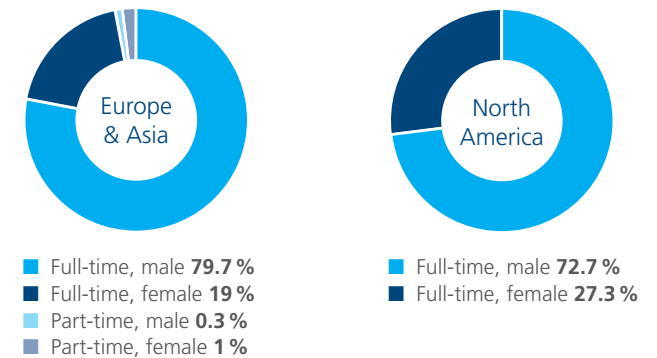

Governance

Two-tier board system

The highest governance body of KIRCHHOFF Automotive GmbH is based on a two-tier board system. It is composed of the KIRCHHOFF Automotive Holding shareholders/managing directors and the KIRCHHOFF Automotive GmbH managing directors board.

As chief officers, the managing directors of KIRCHHOFF Automotive are responsible for the main corporate functions. In 2021, the executive board consisted of Stefan Leitzgen, Hagen Reck, Dr. Thorsten Gaitzsch, and Ken Gibbons.

The members of the company's board are appointed at the annual general meetings for one financial year, and are supervised and supported by the Board of KIRCHHOFF Automotive Holding.

The Board of KIRCHHOFF Automotive Holding consists of managing directors, the majority of which are the shareholders of the company. J. Wolfgang Kirchhoff is one of the shareholders and as Chief Executive Officer, chairs the executive board of KIRCHHOFF Automotive.

Membership of the shareholders in the highest governance bodies of KIRCHHOFF Automotive prevents conflicts of interest with regard to its members. They regularly chair the management meetings: the monthly chief officers' meeting and the bi-annual global executive team meeting, which is also attended by the executive vice presidents of global functions.

Responsibilities for sustainability matters

In order to ensure the company's sustainable development and that it meets its commitments to environmental and social sustainability, as well as to the Code of Conduct, the company's highest governance bodies have assigned appropriate responsibilities to their members. As Chief Operating Officer, Stefan Leitzgen is responsible for environmental sustainability. As Chief Financial Officer, Hagen Reck is responsible for social sustainability. In order to ensure compliance with the automotive industry's ethical standards and respective countries' laws in which KIRCHHOFF Automotive operates, the role of Global Executive Vice President of Governance Risk Compliance has been established. In this position, Janusz Sobon is responsible for global compliance.

The Chief Executive Officer has authority over and responsibility for the company's governance principles, and oversees governance, risk, and compliance (GRC) at the highest governance body level. The CEO supports the GRC function to enable its direct access to the highest governance bodies, ensure its independence, and allocate appropriate authority and resources.

The executive board is supported by the Compliance Committee in the development and performance of sustainability. It is composed of seven members from the company's senior management. The Compliance Committee coordinates and controls all sustainability-related activities. As CEO of KIRCHHOFF Automotive, J. Wolfgang Kirchhoff chairs the Committee.

Managing Directors



Stefan Leitzgen
Global Chief Operating Officer
KIRCHHOFF Automotive



Hagen Reck
Global Chief Financial Officer
KIRCHHOFF Automotive



Dr. Thorsten Gaitzsch
Global Chief Technology Officer
KIRCHHOFF Automotive



Ken Gibbons
Chief Financial Officer
KIRCHHOFF Automotive North America

Shareholders / Managing Directors Holding



Arndt G. Kirchhoff
Chairman of the KIRCHHOFF Group
advisory board



J. Wolfgang Kirchhoff
Managing Partner KIRCHHOFF Group,
CEO KIRCHHOFF Automotive



Dr. Johannes F. Kirchhoff
Managing Partner KIRCHHOFF Group,
CEO KIRCHHOFF Ecotec



Claudius Bensberg
CFO KIRCHHOFF Group

Risk Management

KIRCHHOFF Automotive's risk management system is used for strategy development and planning, implementation, control, and continuous improvement processes in its corporate departments and operational facilities. It increases our awareness of our impact on customers, employees, suppliers, business partners, local communities, and the environment. It also ensures that we can manufacture and provide all products and services properly.

Our strategic risk management covers numerous risks at company level. These include:

- Fluctuations in markets and volumes,
- Compliance risks,
- Global economic and political risks,
- Financial risks, such as availability of funds, interest rate levels, and exchange rates,
- Availability and prices of raw materials and other goods,
- Risks regarding technical development and production technology,
- Cybersecurity.

Additionally, the system provides all plants with a common framework, terminology, tools, and methods to identify, assess, and address risks in a consistent manner. The risk scenarios at plant level fall into three categories:

- Risks from natural disasters such as earthquakes, floods, or pandemics,
- Plant risks, such as the failure of key machinery, power, or personnel,
- Risks to the continuation of business operations, including but not limited to damage of tools, fire, staff strikes, cyber attacks, or interruption to material supplies.

As a result of regular risk assessments, we have identified a large number of key points and checked for their effectiveness. Preventive maintenance, spare parts management, and contingency planning are among the most important risk mitigation factors.

Responsibility for strategic risk management lies with the heads of the global departments, while responsibility for the management of corporate risks lies with the heads of the operating units. The implementation and effectiveness of the risk management system is the responsibility of the Risk Committee, which is composed of nine members from the company's highest management bodies.



Vision and Values

As a family-run company, vision and values are particularly important to KIRCHHOFF Automotive. For generations, living shared values has formed the basis for trusting cooperation and entrepreneurial success. First and foremost, this includes the company's commitment to its employees - but also to the society in which we do business. In 2015, the owners of KIRCHHOFF Automotive defined the company's vision and values, and communicated them to all employees and business partners. To this end, we have translated the vision and values into eight languages, and established training on them as a mandatory part of the onboarding process for new employees.

Vision and values are the foundation and framework for the sustainability of our actions. They create unity, set common goals, and underline our claim: In everything we do, we want to be among the best.

Our Vision

- KIRCHHOFF Automotive is a global leader in the development and supply of best-in-class structures for vehicle bodies and chassis.
- The company generates sustainable and profitable growth to remain financially independent and family owned.
- KIRCHHOFF Automotive is guided by the performance principle and stands for the highest level of customer service.
- The company qualifies its employees and actively promotes their health and satisfaction.

Our Values

Values commit us to sustainable action for the company, for nature and society:

- Honesty and reliability
- Trust and respect
- Social, environmental, and cultural responsibility

We assume responsibility as a sponsor of charitable projects and in the education and training of people. To preserve nature and biodiversity, we protect the environment by using resources sparingly and observing strict environmental standards.



Code of Conduct

The KIRCHHOFF Automotive code of conduct is based on our Vision and Values. It makes our management systems fit the growing demands presented to us, our customers, and society, with regard to sustainability and corporate social responsibility. This is a standard that we ourselves, our customers, and society place.

The aim of the KIRCHHOFF Automotive code of conduct is to promote environmental responsibility, fair and healthy working conditions, and ethical and sound business relationships throughout the KIRCHHOFF Automotive organization.

Our Commitments

- We comply with labor laws and respect human rights.
- Integrity is the foundation of our actions.
- Our company's data and information management is clear and transparent.
- Nature and biodiversity are important to us and future generations to come.
- We ensure that employees have access to open and respectful communication.

We have translated the code of conduct into eight languages for our employees, and displayed the five commitments on posters in local languages at all our sites.

The complete code of conduct is also available on the KIRCHHOFF Automotive website.

Our employees are the heart of KIRCHHOFF Automotive. By familiarizing them with the rules of the code of conduct, we ensure the sustainable development of the company and jobs. Our worldwide production and administration employees have undergone appropriate training. We have also made this a compulsory part of the onboarding process, so that new employees are trained on an ongoing basis.

In order to continuously expand our corporate social responsibility, management regularly reviews new projects and puts them into effect. This includes measures for occupational health and safety and ethical business practices, as well as concepts for even more social commitment at our locations. We have also developed guidelines for risk management, combatting corruption, and dealing with whistleblowing, ultimately creating a set of rules that brings our vision and values to life.

Code of Conduct

Our Code of Conduct outlines commitments and principles that KIRCHHOFF Automotive Employees and external Business Partners, such as Suppliers, are expected to observe.

HUMAN RIGHTS
We comply with Labor Regulations and Respect Human Rights

INTEGRITY
Integrity is the Foundation of Our Actions

DATA
Our Company's Data and Information Management is Clear and Transparent

NATURE
Nature and Biodiversity is Important to Us and to Future Generations

COMMUNICATION
We Ensure Employees Have Access to Open and Respectful Communication

Read the complete texts under:
<https://www.kirchhoff-automotive.com/corporate-governance/code-of-conduct/>

KIRCHHOFF
AUTOMOTIVE

At KIRCHHOFF Automotive, the five commitments from the Code of Conduct are posted at all locations in the local language.

Memberships

KIRCHHOFF Automotive and the Kirchhoff family are involved worldwide in initiatives, organizations, and associations that support business, the environment, and society. These memberships are valuable for the exchange of experience and knowledge, and help ensure the sustainable development of the company.

Selected memberships

Bundesvereinigung der Deutschen Arbeitgeberverbände (BDA)	Europäische Forschungsgesellschaft für Blechverarbeitung (EFB)	Silesia Automotive & Advanced Manufacturing Cluster (SA&AM)	Ost-Ausschuss der Deutschen Wirtschaft (OA e. V.)
American Society of Employers (ASE)	Associação dos Industriais Metalúrgicos, Metalomecânicos e Afins de Portugal (AIMMAP)	East Automotive Alliance (EAA)	Deutsch-Polnische Gesellschaft (DPG)
Bundesverband der Deutschen Industrie (BDI)	Deutscher Verband für Schweißen und verwandte Verfahren (DVS)	Polska Izba Motoryzacji (PIM)	Atlantik-Brücke
Verband der Automobilindustrie (VDA)	Bundesverband Materialwirtschaft, Einkauf und Logistik (BME)	Associação de Fabricantes para a Indústria Automóvel (AFIA)	UN Global Compact
Forschungsvereinigung Automobiltechnik (FAT)	Fraunhofer Center for International Management and Knowledge Economy (Fraunhofer IWM)	Association of the Hungarian Automotive Industry (AHAI)	Value Balancing Alliance (VBA)
Wirtschaftsverband Stahl- und Metallverarbeitung (WSM)	Automotive Center Südwestfalen (acs)	Asociatia Constructorilor de Automobile din Romania (ACAROM)	Responsible Supply Chain Initiative (RSCI)
Industrieverband Blechumformung (IBU)	RWTH Aachen	American Chamber of Commerce in Germany (AmCham)	Drive+ platform by the CSR Europe
Precision Metalforming Association (PMA)	automotive thüringen e. V.	AHK/IHK Chambers of Commerce and Industry in Germany, Portugal, Poland, Hungary, Romania, Mexico, Ireland, Spain and India	

Sustainability Initiatives

Responsible Supply Chain Initiative

In order to promote sustainability in the supply chain, KIRCHHOFF Automotive co-founded the “Responsible Supply Chain Initiative RSCI e. V.” association at the end of October 2021 (see photo). The association brings together 14 car manufacturers and major suppliers as well as the German Verband der Automobilindustrie (VDA). Its aim is to develop a standardized voluntary verification mechanism to assess the sustainability performance of companies in automotive supply chains, covering social issues, occupational safety, and environmental protection. “The duty of care of companies towards the environment and people has become a central issue in our industry in recent years,” said Christian Arens, KIRCHHOFF Automotive representative and key account manager, upon the founding of the association. “We at KIRCHHOFF Automotive have been engaged for several years now, to a joint development of a suitable instrument to support sustainable corporate policy”.

Drive+

In September 2021, KIRCHHOFF Automotive joined Drive+, a platform for sustainable supply chains offered by CSR Europe (a business network for corporate sustainability and responsibility). The platform is primarily aimed at suppliers and supplier associations. Drive+ is the answer to the challenge of

implementing sustainable supply chains in the automotive industry. Through the platform, all stakeholders work together to meet sustainability requirements and adopt and develop key due diligence tools. The Drive+ partners are also in dialogue with the automotive partnership initiative Drive Sustainability. More about [Drive+](#).



Christian Arens from KIRCHHOFF Automotive (3rd from left) with the representatives of the other RSCI founding members.

Stakeholder Communication

For sustainable business success, KIRCHHOFF Automotive relies on an open and trusting exchange of information with various stakeholders. The following includes our stakeholders and the main channels through which we communicate with them:

Stakeholders	Selected communication channels
Owners	Global and site management meetings, committees, management reports
Clients	Key account management, conversations, audits, workshops, seminars, congresses, trade fair dates, K>MOBIL magazine, sustainability report
Employees	One-on-one conversations, shop floor meetings, workshops, family events, trade union dialogue, website, intranet, company app, live streams, information screens in factories
Suppliers and business partners	Conversations, electronic procurement platform, audits, workshops, seminars, "Supplier of the Year" competition, website, K>MOBIL magazine, sustainability report, press releases
Governments and administrations	Conversations, seminars, congresses, dialogue on legislation, website, K>MOBIL magazine, sustainability report, press releases
Civil society and associations	Bilateral and one-to-one conversations, workshops, career fairs, open days, events, sponsoring, press conferences and press releases, website, K>MOBIL magazine, sustainability report
Financiers	Conversations, workshops, seminars and congresses, trade fairs, K>MOBIL magazine, annual report, sustainability report
Media and opinion leaders	Conversations, trade fairs, press conferences and press releases, interviews, website, K>MOBIL magazine, sustainability report

Economic Performance

When the industries restarted in 2020 after the series of COVID-related lockdowns worldwide, the supply chains held and were considered robust. Then however, the surprisingly strong production of many global industries drained the 'pipelines' of many supply chains. In 2021, the whole automotive industry was facing considerable supply problems with steel, aluminum, plastics, and especially semiconductors. Consequently, KIRCHHOFF Automotive sales have been affected to the same extent as the whole industry's performance, demonstrating stagnation of turnover in 2021, after suffering a remarkable drop during 2019, prior to coronavirus.

In response to the crisis in the industry, KIRCHHOFF Automotive reacted quickly with targeted, strategic actions following comprehensive analysis. This allowed us to come back strong and develop a sustainable competitive advantage. As such, strong partnerships with customers, suppliers, financiers, and other stakeholders have been maintained and allowed continuous planning for further growth.

In 2021, KIRCHHOFF Automotive continued investing; new technologies and facilities were expanding capacities and increasing the competitiveness of our locations worldwide. In the south of the USA, a new plant has been built in Atlanta. There, the production of body parts for the new, battery-powered generation of the Mercedes-Benz SUV is now being set up in two steps. At our North American locations, further extensive investments in new presses are planned for 2022. In Shenyang, China, we implemented a comprehensive plant expansion with the installation of a large press and welding line for a new project with our customer BMW. In order to realize current and future order volumes for structural parts for e-vehicles from our customers, several millions were invested this year into fully automated welding and laser welding systems at our German sites in Attendorn and Iserlohn.

Sales

in mln EUR

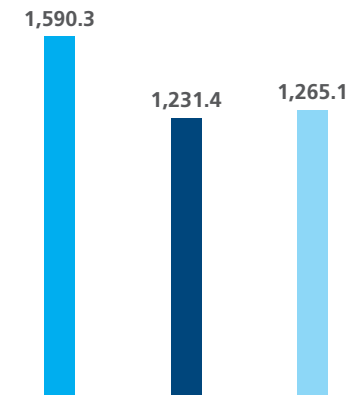

Investments

in mln EUR

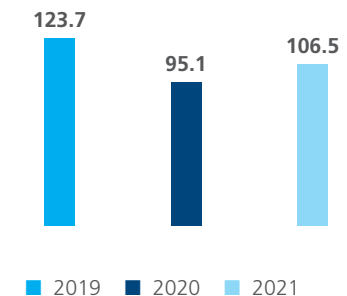

Innovations

Today and in the future, the focus of body development will hone in on cost-effective, holistic, and systemic lightweight design in order to make concept vehicles safe. Thus, KIRCHHOFF Automotive also focuses on the continuous development and constant optimization of safety-relevant components.

In 2021 alone, KIRCHHOFF Automotive was able to win almost 50% of the orders in Europe and Asia for products that will later be installed in battery-electric or hybrid vehicles. This is because the issue of safety plays the same important role in electric vehicles as it does in combustion vehicles. Due to the different vehicle structure, crash components developed by KIRCHHOFF Automotive, such as bumpers or front-end modules, have a different design but are also used in electric vehicles.

Two examples of the research and development projects of KIRCHHOFF Automotive (which have been further developed into innovative products):

Technological Development Expenses (incl. R&D)

in % of external stamping & welding sales

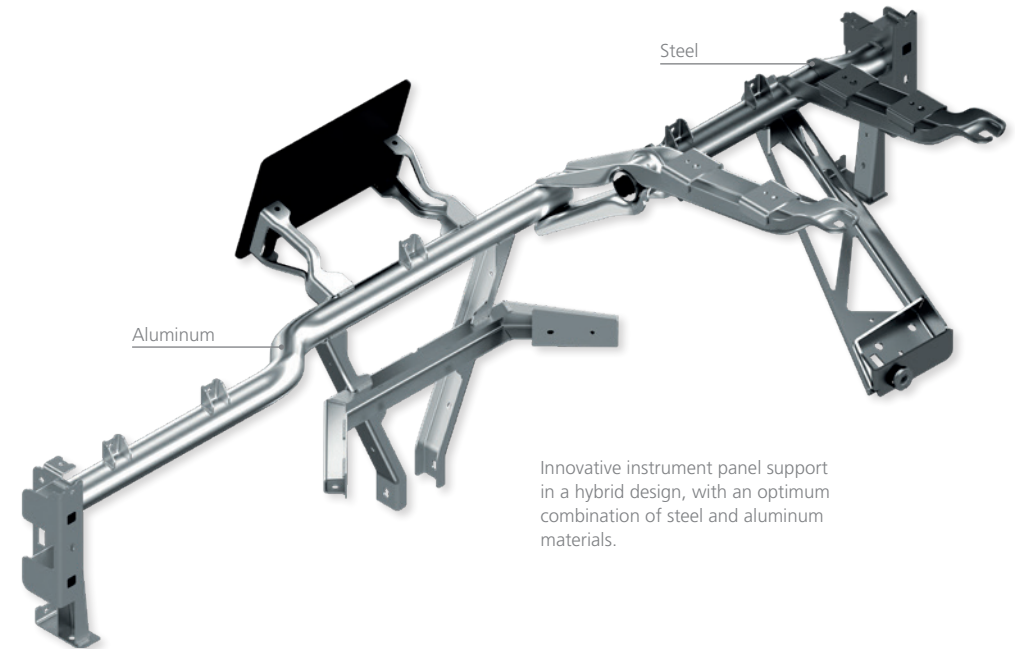
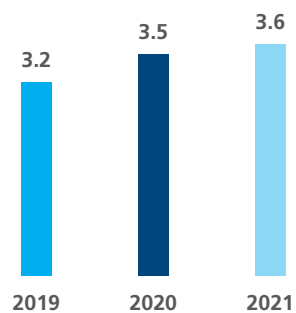

Innovative instrument panel support in a hybrid design, with an optimum combination of steel and aluminum materials.

Economical lightweight construction: instrument panel carrier in a hybrid design

In the development of this innovative instrument panel carrier in a hybrid design, not only were individual components structurally optimized, but the entire carrier was redesigned. The result is a carrier made of steel on the driver's side. Here, high stiffness requirements meet tight installation space conditions so that the material properties of steel (high modulus of elasticity) are optimally utilized.

In contrast, the center and passenger-side areas are made of aluminum. The lower stiffness requirements and more

favorable installation space conditions in this area mean that aluminum offers enormous lightweight design potential. One focus of the development work was the connection between the aluminum and steel components without additional mechanical joining elements. Additionally, the instrument panel support is capable of meeting future infotainment requirements by enabling the integration of a large-area central display and a head-up display. The corresponding mounts allow vibration-free attachment and guarantee a high level of safety.

**Safety in the e-vehicle:
a pre-galvanized crash management
system with high deformation
capacity**

The consequences of a collision with a tree are often dramatic. The central load application leads to strong intrusions and poses an extreme risk to the vehicle's occupants. These scenarios are protected by a newly developed crash management system (CMS) in which the load paths and components have been adapted to this load case.

The CMS enables continuous energy absorption over long intrusion paths without complete failure, thus protecting the occupants and the battery. The reliable processing of pre-galvanized steels is a challenge for the joining technology. As such, a MAG welding process was optimized for galvanized materials used in process-reliable and low-porosity welding, while ensuring sufficient paint adhesion, particularly in the joining zones. Furthermore, a fully laser-welded concept has been realized for the first time.

Advanced crash management system: a MAG-welded and fully laser-welded variant.

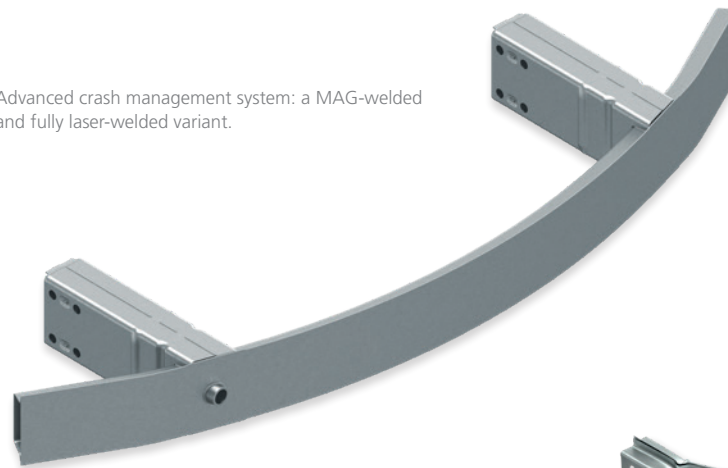

Advanced crash management system with high deformation capacity.



The pile test: demonstrates that CMS allows continuous energy absorption over long intrusion paths without complete failure.



WE.MOVE.FUTURE

Ethical Business

Anti-Corruption and Conflicts of Interest

KIRCHHOFF Automotive rejects corruption and is committed to acting in accordance with applicable anti-corruption laws and standards adopted in the automotive industry. We are aware that our employees may be exposed to different types of behavior in their daily business activities around the world, which may pose a potential risk of corruption. KIRCHHOFF Automotive has taken various measures to prevent any resulting infringements of the law.

We have adopted an [anti-corruption policy](#) and communicated it to management and employees at all locations. Our business partners can access the mentioned policy on our website. In a second step, we derived concrete guidelines on dealing with customers and other stakeholders. These guidelines were translated into all the national languages of our locations, and were also made available to all employees.

Another aspect of corruption prevention is the ethically appropriate handling of conflicts of interest. KIRCHHOFF Automotive has issued a set of rules to be followed in the event that such conflicts are identified within the company.

E-learning on anti-corruption

The key element in communicating our guidelines on corruption and conflicts of interest is an e-learning tool that we have set up in eight languages. The training includes basic information on both topics, our internal guidelines, and explanations on the obligatory behavior if faced with possible cases of corruption or conflicts of interest. The training has been carried out since the fourth quarter of 2021.

In the reporting period, all KIRCHHOFF Automotive sites conducted assessments of their corruption risk. The risk was generally assessed as low, and the existing risk controls were considered adequate and effective. In 2021, KIRCHHOFF Automotive was not involved in any corruption cases.

Participants in the e-learning on anti-corruption and conflicts of interest

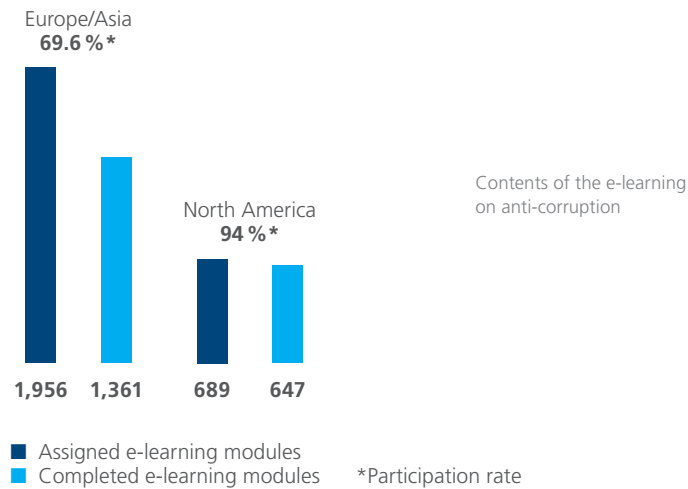

Whistleblowing

KIRCHHOFF Automotive has established a whistleblowing process as a safeguard mechanism for compliance with the commitments adopted in our Code of Conduct and related policies. It is an integral part of KIRCHHOFF Automotive compliance management and is based on legal and industry requirements. Our [whistleblowing policy](#) has been communicated to the employees and is also available on our website for external stakeholders to view.

Participants in the e-learning on whistleblowing for managers

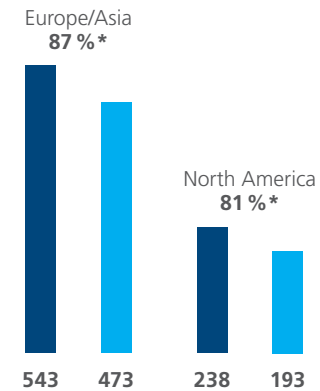

■ Assigned e-learning modules
 ■ Completed e-learning modules *Participation rate

The main objective of the policy is to create a corporate culture in which all employees feel encouraged to share their concerns regarding any aspect of ethical business, compliance with human rights, safety and labor standards, environmental protection, and illegal or unethical behavior. To implement the policy, we have developed detailed guidelines that have resulted in our whistleblowing process. It exists in all eleven countries where we have plants. In addition, we have appointed Compliance Delegates in each of these countries so that employees can also communicate their concerns in the local language. There is a joint responsibility for Portugal and Spain. At the corporate level, we have created the role of Global Compliance Expert. Delegates are responsible for ensuring that the issues raised are addressed and that the whistleblowing process is effective.

The whistleblowing process

Employees can report potential compliance violations via secure communication channels set up specifically for this purpose. We keep all information confidential, protect the identity of whistleblowers, and ensure that there is no retaliation. Our whistleblowing system is also open to external parties, where they can contact our ombudsman, a lawyer. He supports them and guarantees the anonymity of whistleblowers.

A sustained communication campaign is underway to raise employees' awareness of whistleblowing. Posters and documents on the topic are available at all locations in all national languages. In the reporting period, our focus was also put on

training; KIRCHHOFF Automotive has developed a separate e-learning module on whistleblowing. The target group are managers who are supposed to support their employees in such cases.



The internal poster contains all the information about whistleblowing at KIRCHHOFF Automotive. The [contact details for the ombudsman](#) are also available on the company website.

Compliance

KIRCHHOFF Automotive considers it a strong obligation to always act responsibly, ethically, and sensibly in its business operations, and to comply with all applicable laws and regulations. This principle of compliance is also stipulated in our Code of Conduct. It is demanding to be active worldwide, because this requires compliance with the laws of different countries as well as international regulations. To meet this challenge, we have created a compliance function in our company. Our Governance Risk Compliance team is constantly developing our compliance management system.

When it comes to legal compliance, due diligence is of paramount importance. All applicable laws and regulations must be known to an organization, interpreted appropriately, and communicated to all affected parties. As a result, responsibilities often need to be defined, and policies, systems, and/or processes need to be introduced or improved. An important step on the way to our compliance goal is tailor-made training for the employees concerned at KIRCHHOFF Automotive.

Compliance risks assessment is an essential part of due diligence. Compliance risks are defined as the failure to comply with our Vision and Values, Code of Conduct, and related laws, policies and standards relevant to our company's business operations, products, and services, which could result in the loss of a contract or customer, or reputational damage, legal sanctions, and/or financial loss.

Compliance risk assessment

In the reporting period, KIRCHHOFF Automotive carried out its annual compliance risk assessment on two levels: in the operating sites and at the corporate level. Managements from all business units and corporate departments participated in the risk assessment. Their survey included the following scenarios:

- Corruption (S1)
- Fraud (S2)
- Conflicts of interest (S3)
- Intellectual property and confidential information (S4)
- Fair competition/antitrust law (S5)
- Privacy and identity protection (S6)
- Human rights and labor standards (S7)
- Accounting standards and tax laws (S8)
- Prohibited chemicals/hazardous substances (S9)

Managements expressed great confidence in their units. We have classified the individual risks in a KIRCHHOFF Automotive risk matrix, divided up according to operating sites and corporate perspectives (see diagrams: S1–S9 stand for the listed scenarios). None of the compliance risks were considered to be significant. One of the results of the risk assessment was the recommendation to create new control measures in the areas of privacy and data protection, as well as intellectual property and the confidentiality of information.

Corporate level

		Probability			
		unlikely	possible	likely	high
Impact	extreme				
	major	S8	S4		
	moderate	S2 S3 S5 S6 S7 S9	S1		
	minor				

Operating sites

		Probability			
		unlikely	possible	likely	high
Impact	extreme				
	major				
	moderate	S1 S2 S3 S4 S5 S6 S7 S8 S9			
	minor				

Confidentiality, Data Protection & Cybersecurity

Confidentiality is one of the principles adopted by the management of KIRCHHOFF Automotive and is expressed in our Code of Conduct. We require all employees to protect confidential information in whatever form (documents, digital data, knowledge). There is a strong awareness of this within the company.

In order to protect information as effectively as possible, KIRCHHOFF Automotive is continuously developing its Information Security Management System (ISMS). Information security encompasses all processes and tools used by a company to protect sensitive employees' and business' data from unauthorized disruption, modification, destruction, and inspection. It is conceptually broader than IT security, because at KIRCHHOFF Automotive we protect not only digital data, but also paper documents, buildings, rooms, and knowledge.

Further training

An important component of the ISMS is employee training on the topic of cyber security. In 2021, 80% of our employees in Europe and North America who use a company email address participated in phishing awareness training. In addition, KIRCHHOFF Automotive simulated a global phishing attack on the company in order to train employees in the correct ways to react. In the course of 2022, the ISMS team wants to offer standardized company-wide ISMS training together with the HR department.

Our aspiration for constant improvement in data protection is also expressed by certifications. By the end of 2021, four of our sites had been audited and certified according to TISAX (Trusted Information Security Assessment Exchange), a standard established by the German Automobilverband VDA. It concerns the secure processing of business partners' information, the protection of prototypes, and data protection in accordance with the General Data Protection Regulation (GDPR) for possible business transactions between car manufacturers and their service providers or suppliers. In the coming years, we want to certify more locations accordingly.

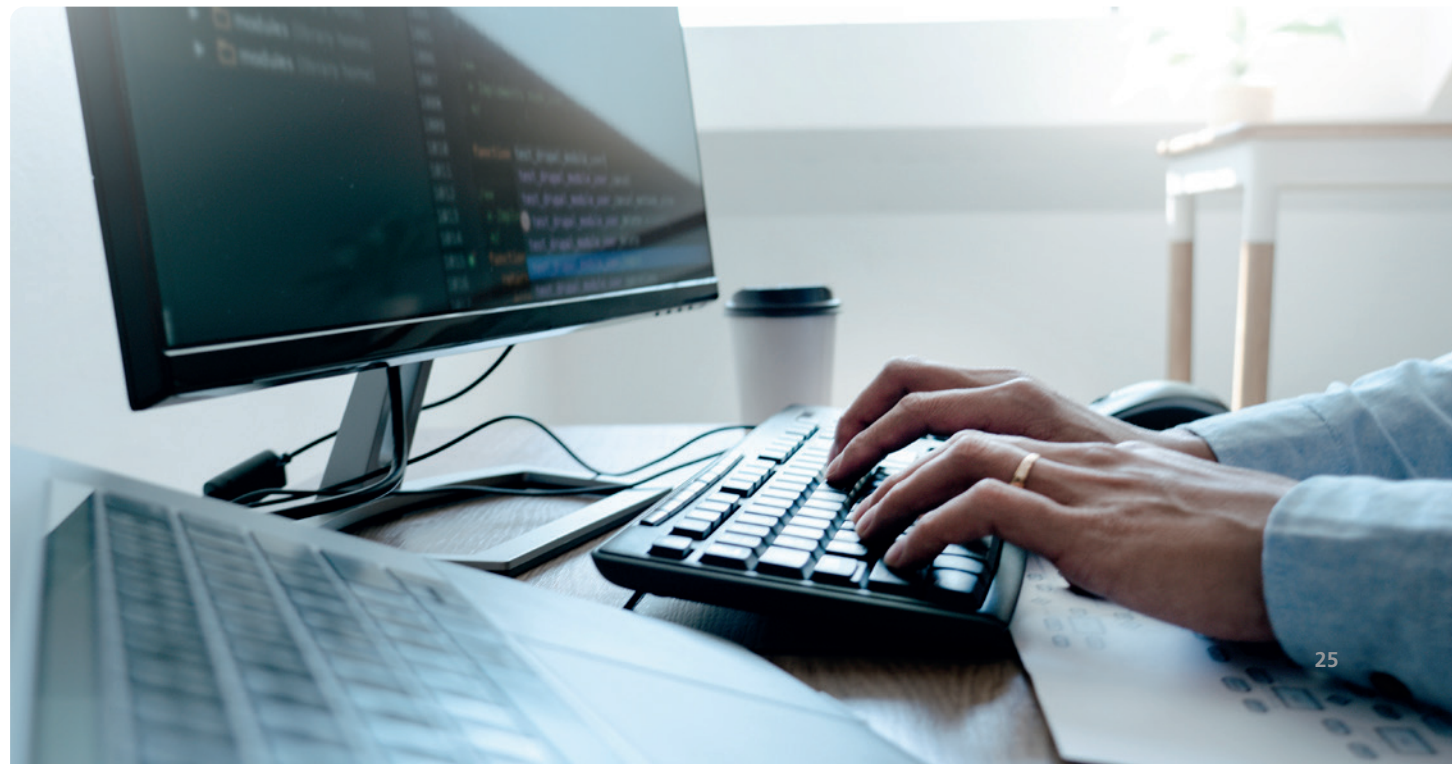

Procurement Practices

Sustainability requirements for suppliers

KIRCHHOFF Automotive is committed to responsible procurement. Our suppliers are obliged to comply with applicable laws, especially with regard to corruption, money laundering, minimum wages, and antitrust and competition law. Our supplier management ensures that the high standards of KIRCHHOFF Automotive with regard to labor and human rights, corporate ethics, and the environment are respected in our supply chain. To this end, all suppliers and their subcontractors must comply with our Code of Conduct and the "Supplier Supplement".

Environmental protection is becoming increasingly important in the automotive industry, and we have also taken additional measures. This is because ecological progress can only succeed if all those involved in the supply chain join in. Therefore, we have tightened up existing environmental requirements and communicated them to our suppliers for the first time in October 2021 – in an "Environmental Supplement" to our Code of Conduct. Since then, our suppliers have had to anchor the following aspects strategically and operationally in their companies:

- Sustainable resource management and avoidance of waste
- Reduction of greenhouse gas emissions
- Expansion of energy efficiency and the share of renewable energies
- Improvement of air and water quality
- Reduction of water consumption
- Responsible handling of chemicals

Supplier diversity

We have set ourselves the goal of strengthening small businesses run by women, ethnic minorities, or members of vulnerable groups. In North America, we ensure this diversity in the supply chain through our "Supplier Diversity Program". It stipulates that KIRCHHOFF Automotive North America obtain at least 5% of its products and services from M/WBE suppliers (Minority and Women-owned Business Enterprises). We have

exceeded this target every year since 2019. In 2021, the share was around 6.7%. We are involved in organizations that bring us into contact with such companies, such as the US Small Business Administration (SBA), the National Minority Supplier Development Council (NMSDC), and the Canadian Aboriginal and Minority Supplier Development Council (CAMSDC). We also encourage our other suppliers to work with M/WBE suppliers.





WE.MOVE.FUTURE



Environmental Sustainability



Materials and Waste

KIRCHHOFF Automotive’s products are mainly made of recyclable steel and aluminum. Especially when it comes to steel, the automotive industry is already approaching a closed-loop economy; worldwide, 90% of the steel used in the industry is recovered. The more frequently steel is recycled, the better its eco-balance. Another advantage to using steel is that it is one of the few materials that does not lose any of its properties during recycling. Melted down and reprocessed steel is of the same high quality as virgin steel.

As approximately 95% of our total GHG emissions is allocated to scope 3, KIRCHHOFF Automotive focuses on the efficient use of materials and the avoidance of process waste. The use of materials is based on established technical standards. We monitor it continuously and take corrective action in the event of deviations. That is exactly how we operate; waste (primarily steel and aluminum waste, but also oils, paper and wood) is fed externally into the recycling loop, thus reducing resource consumption and the negative impact on the climate.

In 2021, our consumption of steel and aluminum increased by 8% compared to the previous year. Compared to 2019, there is a 14% decrease, which is explained by the production volume driven by the customers’ orders over the three consecutive years. The proportion of scrap steel used has hardly changed over the years.

Raw Material Input* and Process Loss in tonnes

Raw material

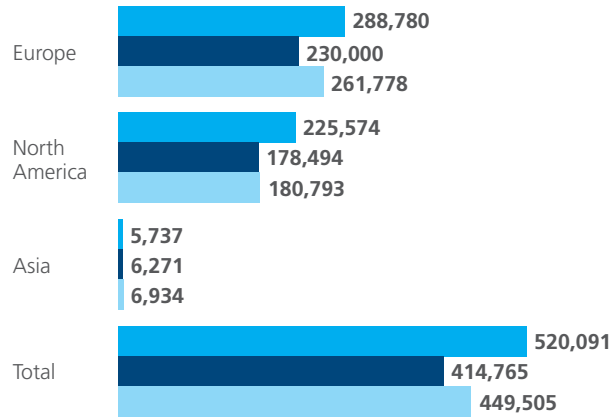

Of which is scrap steel

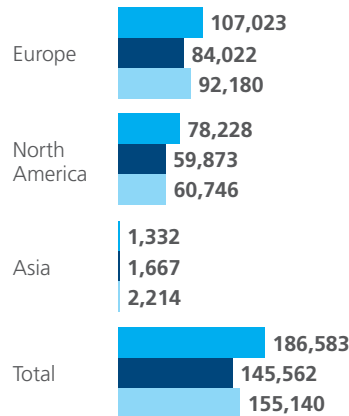

■ 2019 ■ 2020 ■ 2021 *Steel and aluminum



Energy and Water Consumption

Ecological responsibility is an important value for KIRCHHOFF Automotive. We are committed to environmental protection and resource conservation, and want to manage and develop our company in a way that is not only economically but also ecologically and socially sustainable.

96% of our plants have environmental management systems that are ISO 14001 certified. Currently, certification is pending for the Atlanta plant, which opened in 2021. In nine plants, energy management is also certified according to ISO 50001. In recent years, KIRCHHOFF Automotive has continued to standardize the reporting of environmental key figures.

Global standards now exist for energy and water consumption as well as CO₂ emissions. We are currently refining the reporting on waste disposal.

Measures to reduce consumption

Electricity accounts for 53% of KIRCHHOFF Automotive's energy consumption, with gas for 43% and other fuels for 4%. Since 2019, we have been able to reduce total energy consumption by almost 9%. In addition to the economic consequences of the coronavirus pandemic and the resulting semiconductor crisis, various cost-cutting measures have contributed to this. As of 2021, we had converted processes and technologies globally in a total of 46 different projects and made them more energy efficient.

We want to integrate and standardize best practices across the company with regard to energy consumption. To achieve this, we have reviewed our existing processes and technologies along the guidelines defined by the EU Commission's Joint Research Centre as best environmental management practices for the production of metal products. We have also identified our own best practices. For example, the KIRCHHOFF Automotive site in Saarwellingen has installed a new water cooler which, compared to the old model, saves 130,000 kilowatt hours of electricity, around 33 tonnes of CO₂, and several tens of thousands of euros in costs annually. Furthermore, we are increasingly using LEDs for lighting and have expanded the automatic shutdown of unused machines.

Total Energy Consumption in gigajoules

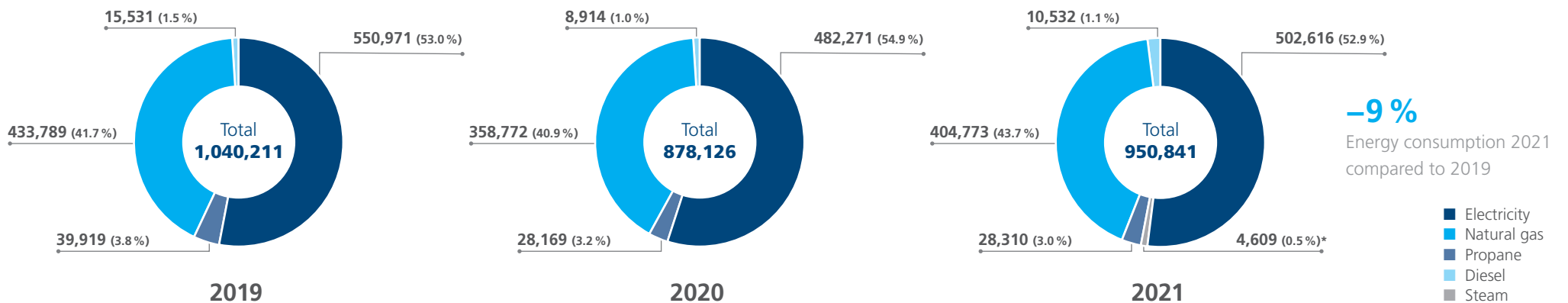

Overall, KIRCHHOFF Automotive's **electricity consumption** fell by 9% due to the economic situation and savings at our plants. On average, our production plants covered 54% of their electricity requirements from renewable sources in 2021; at four locations this figure was already 100%, and at two others it was 95%. We are continuing our efforts in this direction and have set up a roadmap for the supply of green energy. These include a feasibility study for the installation of solar plants at several locations, as well as the testing of a biogas plant for the methane supply of a German factory.

Among other things, we use **natural gas** to heat our plants, for hot forming, and for the coating systems. The bottom line here was a reduction of 7%.

The consumption of **propane and diesel** has decreased significantly. At our European sites, we are continuing to move away from propane and intend to take corresponding measures at other plants as well. Currently, propane is still used in US plants to power forklifts and floor cleaners.

We use **water** at all locations for the bathrooms and cafeterias, and for cleaning and cooling. Water consumption is particularly high in production plants where hot forming and coating (e-coating) are carried out. The reduction in water consumption by 13% can be explained not only by the pandemic but also by local measures to save water.

Energy Consumption by energy source

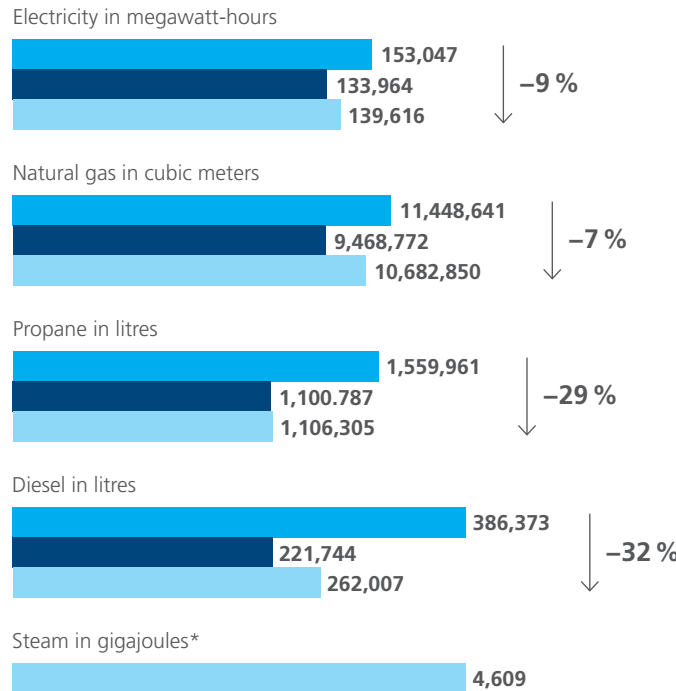

Water Consumption

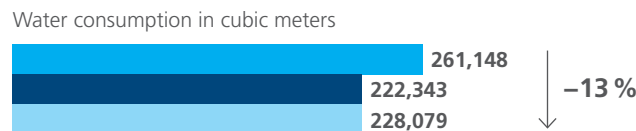

■ 2019 ■ 2020 ■ 2021

*Value collected only for 2021

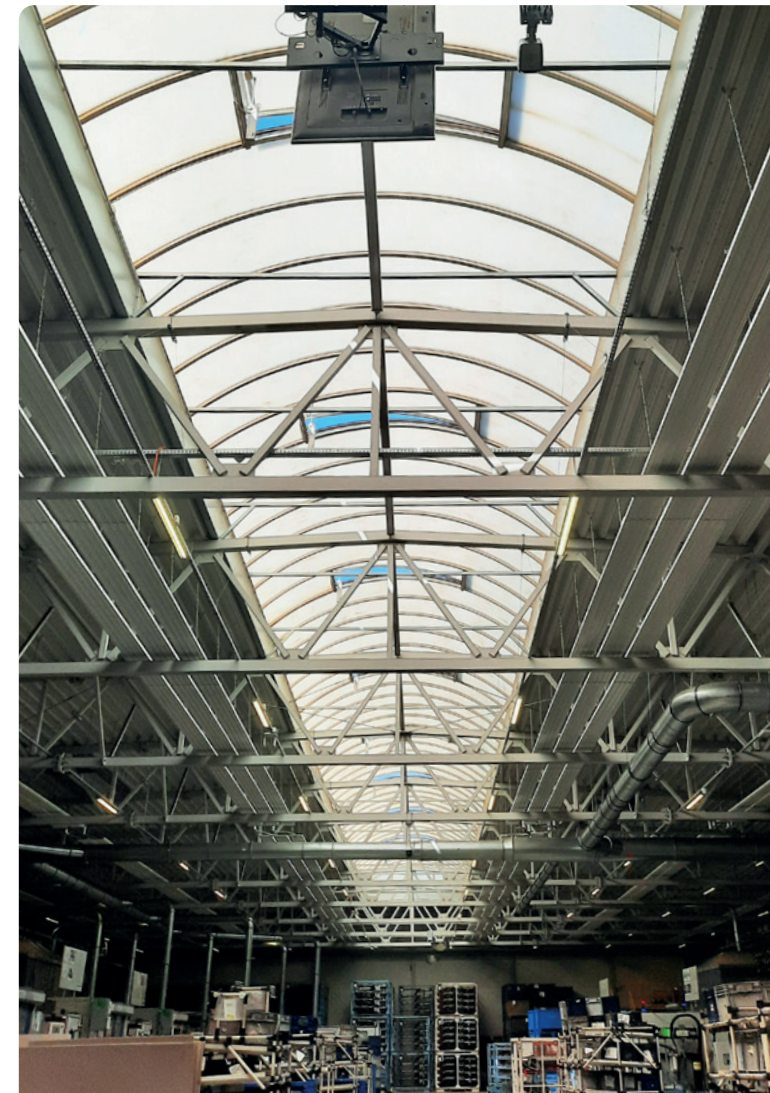

Modern LED lighting in our Gniezno plant, allowing a 75% reduction in lighting energy consumption.

Greenhouse Gas Emissions

Since 2020, KIRCHHOFF Automotive, with the support of its owners, has been developing a strategy to reduce CO₂ emissions. We have set these initial work goals:

- KIRCHHOFF Automotive wants to be climate neutral by 2045.
- We aim to reduce direct and indirect energy-related (scope 1 and scope 2) emissions by 80% by 2030 compared to 2019 levels.

In order to achieve this, we have formed cross-site working groups to identify further CO₂ reduction measures. They should also get a clearer picture of the other indirect emissions that arise in the course of our operations and in our supply chain (scope 3).

Since 2012, KIRCHHOFF Automotive North America has been reporting CO₂ emissions from our sites there to the Carbon Disclosure Project (CDP). In 2018, we also included the German sites in our CDP report, and finally, since 2019, all plants worldwide have been included.

CO₂ balance

Since 2019, KIRCHHOFF Automotive has reduced its overall emissions by 17%. The indirect emissions (scope 2) from electricity and steam generation account for 71% of our total emissions. Since 2019, we have been able to reduce these indirect emissions by 20% because we use more electricity from renewable energies at our sites.

Four factories now use 100% green electricity, and two others use 95%. Our goal is to have only CO₂-neutral electricity by 2030, or acquire compensation certificates. The optimization of our manufacturing processes and environmental management have also contributed to the reduction of electricity consumption and thus of indirect emissions.

Our direct emissions (scope 1) have decreased by 10% since 2019. The reasons for this are both the economic consequences of the COVID-19 pandemic and the bottlenecks in semiconductors, and our efforts to minimize costs effectively.

Since 2019, there has been a 6% decrease in CO₂ intensity, measured in CO₂ emissions per 1 million euros of turnover. The decline was particularly marked at our North American locations with a 13% change.

CO₂ Emissions in tonnes

Direct emissions (scope 1)

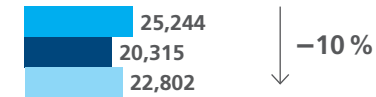

Indirect emissions (scope 2)

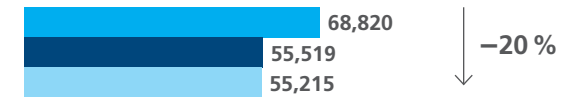

Total

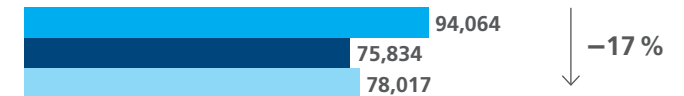

Emission intensity

in tonnes of CO₂ per 1 million euros in turnover



*The total values for 2019 and 2020 were recalculated on the basis of the total internal and external sales.

Biodiversity

As part of its risk management, KIRCHHOFF Automotive has ascertained whether our production sites have a direct or indirect impact on nature conservation areas or areas with high biodiversity. None of our plants are located in or near such an area.

Tree planting campaign

We want to set a global example of how to protect the environment for the future of our children. As a small contribution to CO₂ neutrality, the KIRCHHOFF Group has launched a reforestation campaign and plans to plant 1,785 trees at all of the Group's locations – a reference to the founding year of KIRCHHOFF's original company, Stephan Witte. Together with the tree nurseries and forestry offices, employees and their family members can participate in this campaign.

In 2021, our employees in Germany, Poland, Portugal, Hungary, and Italy participated in the campaign. For example, around 30 employees planted a total of 60 small-leaved limes at the German sites in November.

"It was a great campaign – sustainability for the whole family. We have helped give the barren landscape a new face again," said Peter Kampschulte, Attendorn Forming Plant Manager. Initiator Thomas Kirchhoff was also enthusiastic: "In the end we will have planted almost 100,000 trees for the future – a drop in the ocean, but constant dripping will wear away a stone."



Tree planting in Gliwice, Poland (above) and in Iserlohn. Including: Thomas Kirchhoff, initiator of the project and responsible party for KIRCHHOFF Culture Life (lower picture, on the left), the CEO of KIRCHHOFF Automotive, J. Wolfgang Kirchhoff (lower picture, 2nd from the right), with his wife Friederike (right) and the Iserlohn forester Julia Borghoff.





WE.MOVE.FUTURE



Social Sustainability



Occupational Health and Safety

While our focus in 2021 remained on protecting our employees from the COVID-19 virus, we continued to improve our occupational accident metrics. In recent years, our locations have harmonized and standardized their reporting on these topics. We report and investigate any accidents and near-accidents and track down their causes. Our key figures on occupational safety are based on the frequency and severity of accidents as well as the results and findings of audits. We define accidents during work-related activities for which employees need to seek external medical assistance as "reportable".

Our goal is zero, so all employees go home in the same condition they came to work. The reportable injury rate dropped by 6% to 2.5 reportable injuries per 200,000 hours in 2021 compared to 2.7 in 2020. Sixteen (16) facilities were below the company internal reportable injury rate target, which is two (2) more than the previous year. Eight plants had no reportable injuries, including Figueruelas, Craiova, Pitesti, Suzhou, Shenyang, Atlanta, Queretaro, and Puebla.

Injury severity is measured by the number of days absent per 200,000 hours worked. In 2021, the number of absent days due to injuries increased by 16% (347 days) to 2,501 days. That means 39 days lost per 200,000 hours worked, compared to 33 in 2020. Injury severity remains 19% lower than 2019. Our Queretaro (Mexico), Tecumseh (USA), and Waverly (USA) facilities achieved over 1 million hours worked without a lost time accident and absent days due to injury.

To ensure we are doing the right things to manage employee safety, KIRCHHOFF Automotive has committed to have all locations certified by ISO 45001. In 2021, six additional facilities gained ISO 45001 safety certification. Currently, 15 location are safety certified with seven (7) more facilities planning to gain certification in 2022. ▶

Occupational Health and Safety

Working hours

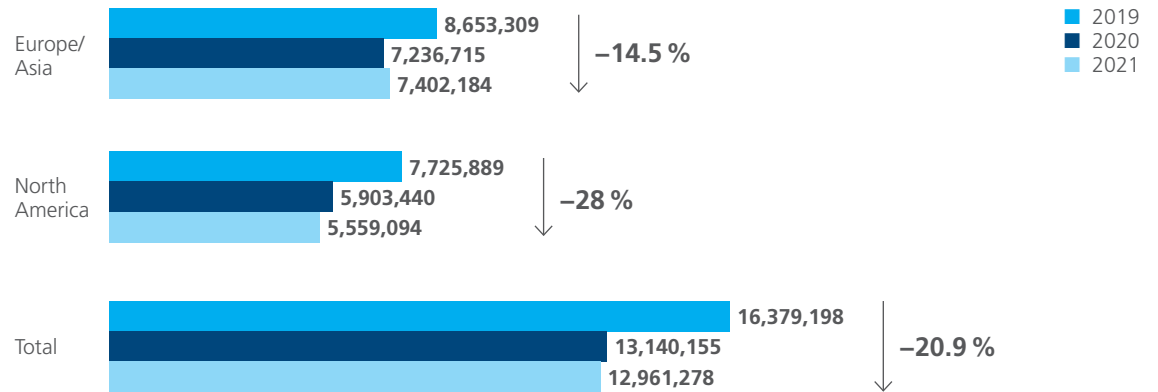

Reportable occupational accidents

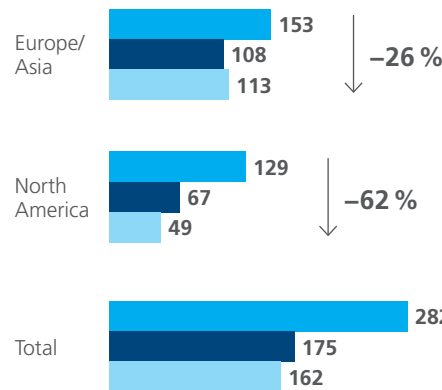

Days absent due to accidents

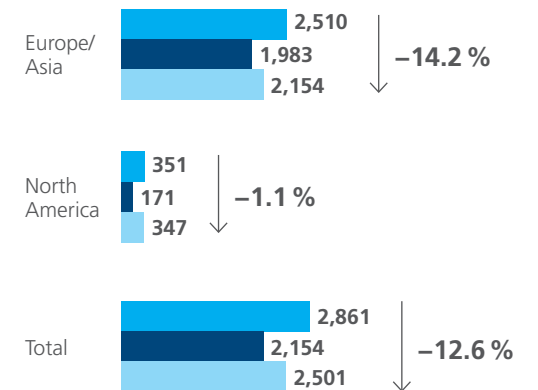

Overall injury prevention is supported by all business functions, including the dedication and efforts of our employees, supervisors, and managers, as well as our health and safety professionals and joint health and safety committees.

The COVID-19 pandemic

Introduced in 2020, we have continued many protective measures against coronavirus. These include compulsory masks, distancing rules, disinfection of surfaces, contact tracing, and coordinated plans for presence at work and working from home. In doing so, KIRCHHOFF Automotive has always complied with the applicable regulations at our locations. Additionally, we have encouraged our employees to get vaccinated.

While protective measures were taken within the facilities, 796 KIRCHHOFF Automotive employees contracted COVID-19 in 2021. From the beginning of the pandemic to the end of 2021, a total of 1,103 contracted COVID-19. By the end of 2021, 94% of employees who had contracted coronavirus, mainly outside the workplace, had recovered and were back in the company.

We thank our employees for adhering to the COVID-19 protection measures at all times and helping to contain the spread of the virus within the company, protecting both their colleagues and families.



Education and Training

KIRCHHOFF Automotive sees its employees as partners and competitive advantages that can hardly be overestimated. Machines can be bought, but people must be found and retained. That is why our human resources policy is aimed at long-term employment and talent development. We believe that motivated and qualified employees contribute to the sustainable development of the company and its environment.

As a global acting company, we benefit from the diversity of our workforces: different cultures, varied approaches to problems, innovative ideas, and decision-making processes. That is why we offer employees a wide range of development opportunities at all our sites.

Our development programs

- **Employee Development Process (EDP)**

The EDP helps identify the development needs of all employees. It identifies core and job-specific competencies and annual development goals. Each employee has at least one annual EDP discussion with their supervisor and receives an individual development plan.

- **KIRCHHOFF Automotive Talent Education (KATE)**

KATE standardizes both the selection of potential candidates and their development program. The program targets employees who are aiming to grow into a management role or a specialist career. The KATE process focuses on employees at the first career stages who have the potential to grow at KIRCHHOFF Automotive.

- **Local Leadership Development Program**

This program is aimed at all managers (team leadership and above) and those who will assume leadership responsibilities within the next six months. The program consists of six modules that teach what is expected of a leader at KIRCHHOFF Automotive.

- **KIRCHHOFF Automotive Academy**

A global program that standardizes training material content for each department. The academy also drives the availability of standardized e-learning materials.

- **Tuition Reimbursement**

Partial course fee reimbursement is a country-specific offer from KIRCHHOFF Automotive. It supports employees' continuing education and helps them enroll in courses or programs that improve their job-related skills.

Continuing Education Hours 2021

Percentage of employees who have undergone further training
100 %

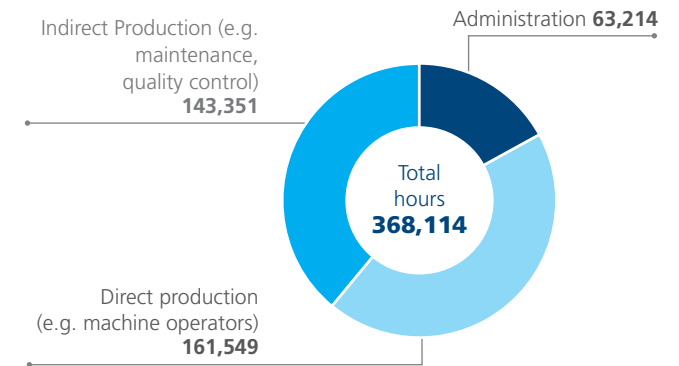

Hours per employee

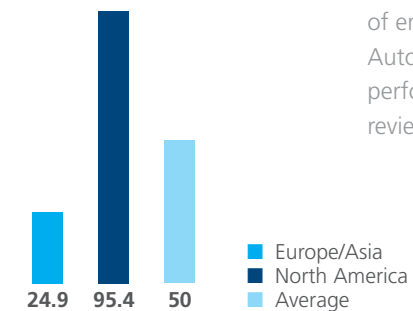

100 %

of employees at KIRCHHOFF Automotive receive regular performance and development reviews.

Freedom of Association and Collective Bargaining

The collective representation of employees' interests has always been an important factor at KIRCHHOFF Automotive. This is reflected, among other things, in the collective bargaining coverage: At the end of 2021, for example, 42% of our employees worldwide were subject to regulations on pay and working hours that were collectively negotiated by representatives of employees and employers – four percentage points more than in 2020. In Europe/Asia it was 44% (+4 points), and 37% (+3 points) in North America. These agreements include both internal and external agreements, such as those involving trade union representatives.

The Kirchhoff family has also long been committed to social partnership between employers and employees. Arndt G. Kirchhoff, Chairman of the Advisory Committee of the KIRCHHOFF Group, is, among other things, President of the Landesvereinigung der Unternehmensverbände Nordrhein-Westfalen. As President of the North Rhine-Westphalian metal and electrical industry employers' associations, he leads collective bargaining for the sector. His father, the late Dr. Jochen F. Kirchhoff, had already been active in the same roles for decades.

Bringing employees along

In addition to wage and salary negotiations, representatives of KIRCHHOFF Automotive's management also meet with employees or their representative bodies. This regular exchange is about providing support for important problems as well as information about the current situation and strategic changes at the company.

Most recently, the shift towards electric mobility - and therefore the future position of KIRCHHOFF Automotive in the supply chain - has been a particular concern for our employees. The plant managers at our locations addressed these concerns as part of a strategy day. They presented forecasts for the global development of electric mobility as well as the lightweight products that the company has developed specifically for electric vehicles.

KIRCHHOFF Automotive also actively involves its employees when shaping the company. They can submit ideas for improvements to production processes via the suggestion system; the best ideas are awarded with prizes and implemented. In this way, we have already been able to create significant change within the organization, thanks to our employees.

Employees With Collective Agreement Coverage 2021



Share in percent

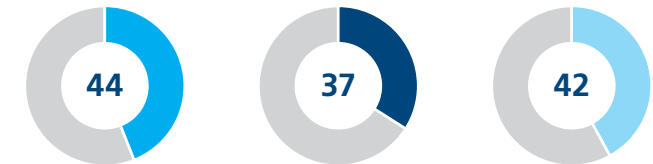

■ Europe/Asia ■ North America ■ Total



Local Communities

KIRCHHOFF Automotive and its employees are committed to society and the environment at our locations worldwide. "Our visions and values are not just on paper, but are expressed in many different activities," emphasizes J. Wolfgang Kirchoff, CEO of KIRCHHOFF Automotive. All in all, we have supported more than two dozen initiatives in recent years, such as the participation or volunteer work of employees and donations in kind. We are always about giving back to the local communities and being more than "just an employer". Some notable examples include:

Flood aid, Iserlohn, Germany

The flood disaster in mid-July 2021 caused massive damage in the region around the KIRCHHOFF site in Iserlohn. For our company, it was immediately clear that we would help. Firstly, KIRCHHOFF Automotive set up a relief fund for employees who were directly affected by the flood to help support them financially. Secondly, the KIRCHHOFF Group launched an appeal for donations to its employees. The owners then supplemented the money collected with a larger sum to support private individuals and private sponsors of social institutions in our region. "I am very happy about the many donations that came in after our appeal. Donations were not just made at the German locations of the KIRCHHOFF Group. Colleagues in North America, for example, also wanted to help when they saw the pictures of the destruction. This shows the important attachment of all of us to this region. We cannot undo the many losses that people have suffered. But, we can help with the reconstruction," emphasised KIRCHHOFF



Artur Rath, Director Operations in Attendorn (right), presents the cheque for 25,000 euros to Manuel Huff, the first chairman of the „Bürger helfen Bürgern“ organization.

Automotive CEO J. Wolfgang Kirchoff. 25,000 euros went to the Iserlohn organization "Bürger helfen Bürgern," which supported flood victims with donations in kind, renovations, visits to the authorities, etc. KIRCHHOFF Automotive helped 11 employees with a sum totalling five figures.

"Cent Amounts", Attendorn, Germany

At our Attendorn site, around 200 employees are currently taking part in the "Cent Amounts" campaign. In doing so, they donate the cent amounts of their pay slips to social causes every month. By the end of 2020, 2,200 euros had been collected, which KIRCHHOFF Automotive passed on to three organizations during 2021. We supported the women's shelter in Olpe with 1,000 euros, the children's and young people's hospice in Olpe with 600 euros each, as well as the

family cancer aid organization Sonnenherz. On July 5, the project leaders visited the hospice in Olpe and symbolically handed over the donation (see photo). When it was founded in 1998, the children's hospice was the first of its kind in Germany, followed by the youth hospice in 2009. It offers families with seriously ill children and adolescents "experience and relief days" for up to 28 days a year, and finances half of its budget through donations. This is not the only reason why KIRCHHOFF Automotive is continuing the "Cent Amounts" campaign and recruiting more participants among the workforce. ▶



Social commitment, Troy, USA

Workers at our site in Troy, Michigan, have supported numerous aid initiatives over the past year. When an apartment building for older people and low-income tenants burnt down in Troy during February of this year, employees donated food, clothing, and hygiene products to the affected residents. In December, they collected relief aid and money for the victims of a devastating tornado in the states of Arkansas and Kentucky. During Advent, they also supported the local “Foster Closet” with Christmas gifts, nappies, and wet wipes. At the volunteer organization, families who have taken in a foster child receive daily necessities, from hygiene products to furniture. This relieves the financial burden on families, especially in the early days of care, and supplements state benefits.

Earth Day, Waverly, USA

The employees at the Waverly site beautified their factory premises with a flower meadow to commemorate Earth Day on April 22, 2021. Supported by the district, they sowed bee-friendly wildflowers and set up a bird bath and two feeding stations for thrushes. KIRCHHOFF Automotive also took part in the annual Honda Week of Service for suppliers of the car manufacturer; around the plant, employees cleaned the roadsides.

Second Chances program, Waverly, USA

Our site in the US state of Ohio is committed not only to the environment, but also to fellow human beings. Waverly has been participating in Pike County’s Second Chances program since May 2020. The program serves as a stepping stone into the labor market for those transitioning out of addiction. Participants with experience in technical activities acquire basic knowledge of various professions in company internships. The

aim is to be taken on in a permanent position. In Waverly, 11 participants completed an internship in 2021. KIRCHHOFF has offered more than half of them a full-time position, and around a third now work permanently at our plant.

Music and more, Manchester, USA

KIRCHHOFF Automotive supports the communities around our locations through charitable campaigns, environmental activities, music, art, and culture. Since 2019, the Lynchburg Music Fest has been a regional music highlight. KIRCHHOFF Automotive, with a plant in neighboring Manchester, was a first-time sponsor in 2021, as one of the main sponsors of the festival. Over two days, 30 musicians performed country and bluegrass, from headliner Cody Jinks to local



newcomers. The employees of the KIRCHHOFF Automotive plant were involved in numerous other initiatives throughout the year, such as, raising funds for flood victims in Waverly, Tennessee, as well as participating in child and breast cancer awareness campaigns. The proceeds of a charity golf tournament benefitted various organizations.

Support for a children’s home, Querétaro, Mexico

KIRCHHOFF Automotive team in Querétaro has had particularly close ties with local children’s homes for years. Before the coronavirus pandemic, our employees donated school backpacks and cleaning supplies to Santa Rosa de Lima, a children’s home with an attached boarding school. During the pandemic, the KIRCHHOFF Automotive plant donated disinfectants and, most recently, shoes, winter clothing, food, and small Christmas gifts.

Robots for students, Puebla, Mexico

In order for them to develop their skills, young professionals already need the best possible equipment during their training and studies. That is why the KIRCHHOFF Automotive plant in Puebla has supported the Instituto Tecnológico Nacional de México campus there with a special donation: an industrial robot also used in manufacturing. Students can gain practical expertise in the automotive sector and other subjects in the processing industry. ▶

Donations and sponsoring, Ovar and Cucujães, Portugal

Our colleagues in Portugal collect relief aid for two social institutions in the region every month. Two boxes go through all the functional areas, the staff fill them with food, and at the end of each month the donations are handed over. In the same way, the workers helped a colleague in a personal emergency. Our two Portuguese locations also make annual financial donations to social institutions, with a focus on supporting children, the elderly, and wildlife. Additionally, used office furniture was handed over to various organizations in 2021. Regional social institutions can also contact our plants "out of turn" at any time. KIRCHHOFF Automotive is happy to organize collection campaigns for clothing or food, for example.

In addition to donations, KIRCHHOFF Automotive is also active in Portugal with sponsoring. We promote running by financing the participation of a running group in competitions. We also sponsor activities and small projects at secondary schools and universities. This includes a women's band from the Polytechnic Institute of Porto.

More nature on the factory site, Germany and Romania

At the Iserlohn site, KIRCHHOFF Automotive installed 20 nesting boxes over the course of last year. Our trainees made them from the waste wood of disposable pallets, and now they serve as breeding grounds for native birds. The inspiration for this came from FAUN, one of our sister companies in

the KIRCHHOFF Group. Its employees, with the support of the environmental protection organization NABU, has also installed nesting boxes at the site in Osterholz-Scharmbeck.

Our employees in Pitesti, Romania, have also brought more nature into the plant. During the "Green Area" campaign in mid-June, various teams of employees presented their ideas

for creating green zones on the company premises. Three to four people formed a team and gave free rein to their imagination. Five beautiful projects were created in which all participants showed creativity, commitment, and teamwork. The green spaces influence the well-being of employees and have a positive effect on health and stress reduction.



KIRCHHOFF Culture Life

“Feel good, be amazed, listen, enjoy, and participate” is how J. Wolfgang Kirchhoff, chairman of the management board of KIRCHHOFF Automotive and co-initiator of KIRCHHOFF Culture Life (KCL), formulated the objective of the cultural initiative. KCL should shape the corporate culture in our company. Since its inception in 2017, there have been painting activities, competitions, concert and exhibition visits, reading evenings, cooking events, musical and sporting participation opportunities, and much more for the company’s employees. The creative mind behind the varied program is Thomas Kirchhoff, cousin of J. Wolfgang Kirchhoff and himself a cultural professional. The university professor is one of the most renowned classical guitarists in the world and has created the “Guitar Symposium” festival in Iserlohn.

In July 2021, Thomas Kirchhoff invited world stars of the scene as guests for seven concert evenings at the International Guitar Festival in Iserlohn. Among them were Grammy winner David Russell from Scotland, the young star Thibaut Garcia from France, and the world-famous tango duo Bandini & Chiacchiaretta. Also, concerts with Łukasz Kuropaczewski from Poland, and three superstars Costas Cotsiolis, Zoran Dukic, and Aniello Desiderio, could be heard during the concert series in the municipal church of Iserlohn. Here, KCL invited the audience with ten pairs of free tickets.

K>LIVE

Because such on-site events were not always possible in the past two years, since the first coronavirus lockdown in spring



For the “Guitar Symposium” festival, Culture Life initiator Thomas Kirchhoff regularly invites world stars to Iserlohn.

2020, KIRCHHOFF Culture Life has regularly become K>LIVE. Many events had to be cancelled, and so the offer moved to the KIRCHHOFF Automotive intranet via a livestream called K>LIVE. This is about the sustainable retention of employees. KIRCHHOFF Automotive keeps in touch with its employees, always informs them transparently about the consequences of the coronavirus and semiconductor crises, and thereby gives them confidence. For this purpose, two of the Kirchhoff brothers were guests at two K>LIVE events at the end of November 2021, and answered questions from employees in the Europe/Asia and North America regions. “In terms of the material situation, the team performed excellently,” said Arndt G. Kirchhoff, Chairman of the Advisory Committee of the KIRCHHOFF Group. “I’m proud of that!” He was referring to the semiconductor

supply bottlenecks, which had also slowed down KIRCHHOFF Automotive at times. When asked whether this year or 2020 has been the bigger challenge for the company, CEO J. Wolfgang Kirchhoff said: “This year is clearly the bigger challenge. Last year we had to deal with COVID-19. This year it is COVID-19 and the problems with the supply chains. But, our company is very well positioned, we are far ahead of others.”



Culture officer Thomas Kirchhoff gave a review of the KIRCHHOFF Culture Life events in the livestreams. Employees have planted 1,785 trees at many locations around the world. Around 100,000 trees have already been planted at 55 locations. In another project, employees from Hungary, Germany, and the USA designed a photo calendar with countryside motifs from their region.







In the Q&A session with management, employees received direct information on the financial year and strategies for the future.

GRI Content Index

This report is based on the [guidelines of the Global Reporting Initiative \(GRI\)](#). The overview shows which information presented meets which GRI standards.

GRI-Standard	UN Sustainable Development Goals	Information	Page
GRI 102: General Disclosures 2016		102-1 Name of the organization	3
		102-2 Activities, brands, products, and services	6–7
		102-3 Location of headquarters	3
		102-4 Location of operations	5
		102-5 Ownership and legal form	2, 3
		102-6 Markets served	7
		102-7 Scale of the organization	5, 18
		102-8 Information on employees and other workers	5, 9
		102-10 Significant changes to the organization and its supply chain	3
		102-11 Precautionary principle or approach	12
		102-12 External initiatives	38–40
		102-13 Membership of associations	15
		102-14 Statement from senior decision-maker	1
		102-16 Values, principles, standards, and norms of behavior	13–14

> GRI Content Index

GRI-Standard	UN Sustainable Development Goals	Information	Page
		102-17 Mechanisms for advice and concerns about ethics	22–23
		102-40 List of stakeholder groups	17
		102-41 Collective bargaining agreements	37
		102-43 Approach to stakeholder engagement	17
		102-50 Reporting period	3
		102-53 Contact point for questions regarding the report	45
GRI 201: Economic Performance 2016		201-1 Direct economic value generated and distributed	18–20
GRI 205: Anti-corruption 2016		205-2 Communication and training about anti-corruption policies and procedures	22
		205-3 Confirmed incidents of corruption and actions taken	22
GRI 206: Anti-competitive Behavior 2016		206-1 Legal actions for anti-competitive behavior, anti-trust, and monopoly formation	22
GRI 301: Materials 2016		301-1 Materials used by weight or volume	28
GRI 302: Energy 2016		302-1 Energy consumption within the organization	29–30
		302-4 Reduction of energy consumption	29–30
GRI 303: Water and Effluents 2018		303-5 Water consumption	29–30
GRI 304: Biodiversity 2016		304-1 Operational sites owned, leased, managed in, or adjacent to protected areas and areas of high biodiversity value outside protected areas	32

> GRI Content Index

GRI-Standard	UN Sustainable Development Goals	Information	Page
GRI 305: Emissions 2016		305-1 Direct (Scope 1) GHG emissions	31
		305-2 Energy indirect (Scope 2) GHG emissions	31
		305-4 GHG emissions intensity	31
		305-5 Reduction of GHG emissions	31
GRI 403: Occupational Health and Safety 2018		403-9 Work-related injuries	34–35
GRI 404: Training and Education 2016		404-1 Average hours of training per year per employee	36
		404-2 Programs for upgrading employee skills and transition assistance programs	36
		404-3 Percentage of employees receiving regular performance and career development reviews	36

The 17 UN Sustainable Development Goals



The 17 global sustainable development goals of the 2030 Agenda, the Sustainable Development Goals (SDGs), are aimed at everyone: governments worldwide, as well as civil society, the private sector and academia

Imprint

© 2022

KIRCHHOFF Automotive Holding GmbH & Co. KG
Stefanstraße 2
D-58638 Iserlohn

Phone: +49 2371 820-00

E-mail: info@kirchhoff-automotive.com

www.kirchhoff-group.com

www.kirchhoff-automotive.com

Publisher:

J. Wolfgang Kirchhoff, CEO, KIRCHHOFF Automotive

Legally Responsible for Content:

Andreas Heine, Global EVP Communication & Marketing, KIRCHHOFF Automotive

Editing and Design:

IW Medien GmbH

Postfach 10 18 63

50458 Köln

Picture Credits:

KIRCHHOFF Automotive

whyframeshot - stock.adobe.com

Pichsakul - stock.adobe.com

Rawpixel.com - stock.adobe.com